

MP PUMPS SERVICE PARTS LIST

- Pedestal Mount Centrifugal
- Belt or Direct Drive

- Sealed Ball Bearings
- Mechanical Seal

SERIES 300
3" X 2-1/2" Pipe Size

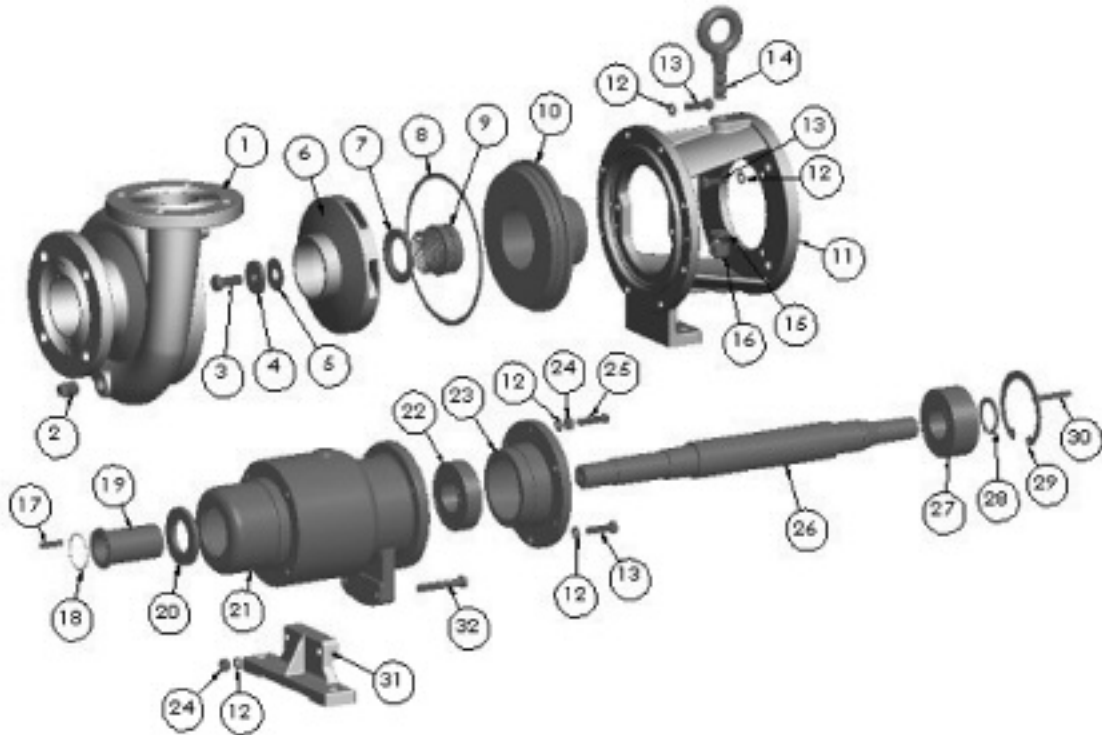

ITEM NO.	PART NO.	DESCRIPTION	QTY.
1	26733	HOUSING- DUCTILE IRON	1
2	22656	PIPE PLUG- S.S. 1/2" NPT	2
3	26674	SEALBOLT S.S.- 1/2-13 X 1.25	1
4	26675	WASHER S.S.	1
5	21403	GASKET- TEFLON	1
6	26700	IMPELLER- DUCTILE IRON 7"	1
7	26372	SPRING RETAINER S.S.	1
8	26744	GASKET	1
9	26685	MECH. SEAL ASY- 1.15" VITON	1
10	26737	MECH. SEAL ADAPTOR- C.I.	1
11	26739	ADAPTOR- CAST IRON	1
12	21266	LOCKWASHER S.S.- 3/8	17
13	21274	CAPSCREW S.S.- 3/8-16 X 1.25	19
14	26686	EYE BOLT STL- 5/8-11 X 2.12	1
15	26258	LOCKWASHER STL- 5/8	1
16	22461	HEXNUT STL- 5/8-11	1

ITEM NO.	PART NO.	DESCRIPTION	QTY.
17	25299	SQ. KEY- 1/4 X 1/4 X 1.25	1
18	33472	O-RING- VITON	1
19	33059	SLEEVE S.S.	1
20	26680	SLINGER- NEOPRENE	1
21	33056	BODY- C.I.	1
22	33053	BALL BEARING	1
23	33051	BEARING RETAINER- C.I.	1
24	21268	HEXNUT S.S.- 3/8-16	5
25	43326	DOG POINT SET SCREW- 3/8-16	3
26	33052	SHAFT	1
27	33054	BALL BEARING	1
28	33057	EXT. SNAP RING	1
29	33058	INT. SNAP RING	1
30	26796	SQ. KEY- 1/4 X 1/4 X 2.12	1
31	26741	BRACKET- C.I.	1
32	21275	CAPSCREW S.S.- 3/8-16 X 2.5	2

* RECOMMENDED REPLACEMENT PARTS

(NOTE: CALL FACTORY FOR MECHANICAL SEAL AND IMPELLER OPTIONS)



MP PUMPS, INC.

34800 BENNETT • FRASER, MI 48026-1686
 (586) 293-8240 • FAX (586) 293-8469
 (800) 563-8006 • www.mppumps.com

FORM 7071-B (10/04)